

# Bar Linear Removable Core Registers



**Not suitable for floor use**

## DABLDR

- Removable core held in place with clips
- Fully extruded aluminum construction for a stylish appearance
- Fixed blades designed for long straight air throw
- Built-in Opposed Blade Damper with sliding operator
- Sections joined together for continuous appearance. When longer than 84", aligning pins are provided.
- Available on 1/2" increments as standard
- Custom sizes available but extra charge may apply
- Durable powdercoat painted finish

**HOW TO ORDER**

**DABLDR\_ - 00 - D 30 x 4 COLOR**

Grid core	-G	Blade	-00,-01	Width & Height	White
No flange	-N		-15,-30	Mounting A, B, C or D	Silver
			-82,-84		Mill or Brown

Do not leave space if option is not required

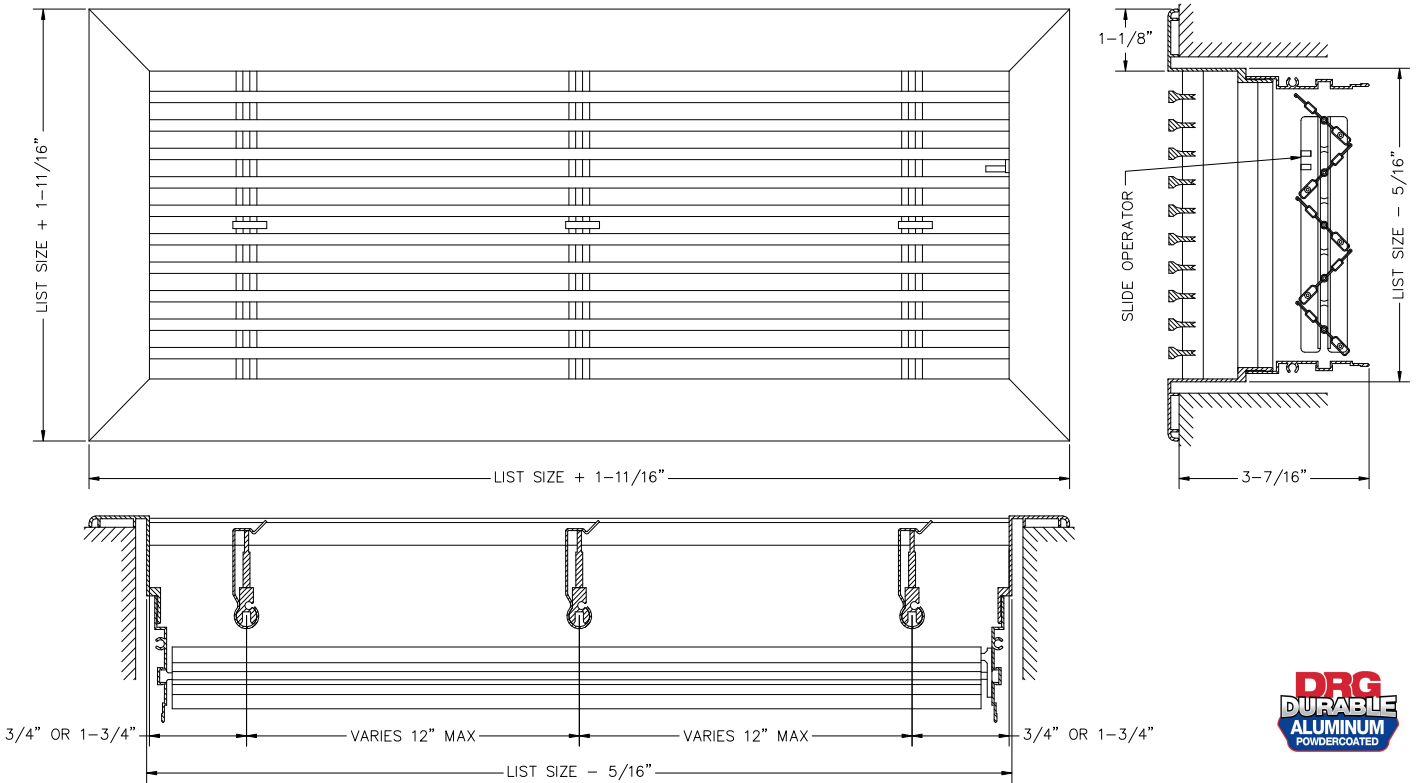

DESCRIPTION	DABLDR
FACE BLADES	Horizontal Fixed
REAR BLADES	n/a
DAMPER	Opposed Blade
MATERIAL	Aluminum
COLOR	White/Silver/Brown/Mill

**JOB NAME:** \_\_\_\_\_

**LOCATION:** \_\_\_\_\_

**ARCHITECT:** \_\_\_\_\_

**ENGINEER:** \_\_\_\_\_

**CONTRACTOR:** \_\_\_\_\_

**Bar Linear Blade Options**

**-00-**

0° 13/64+blades on 1/2+centers

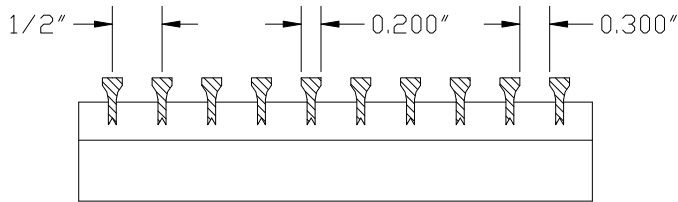

**-01-**

0° 1/4+blades on 1/2+centers

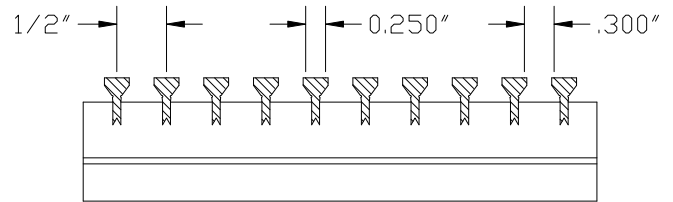

**-15-**

15° 13/64+blades on 1/2+centers

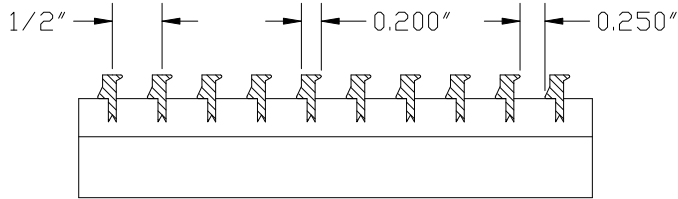

**-30-**

30° 13/64+blades on 1/2+centers

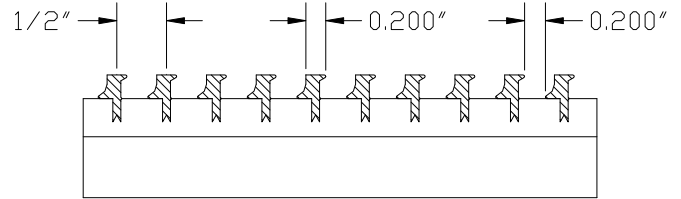

**-82-**

0° 1/8+blades on 1/2+centers

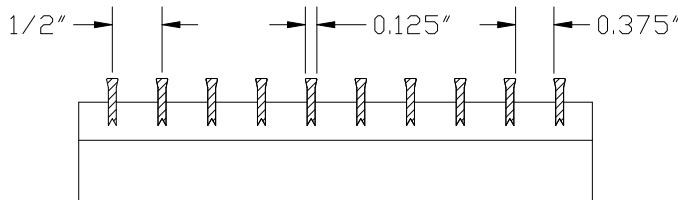

**-84-**

0° 1/8+blades on 1/4+centers

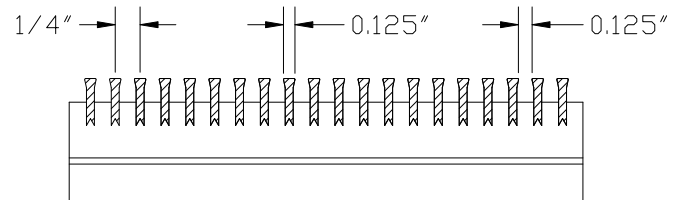

- Additional charges apply for the -84 core option

**Bar Linear Mounting Options**

**-A**  
SCREWS

Color matched screws with counter-sunk screwholes.  
Suitable for ceiling, wall, sill or floor installation.

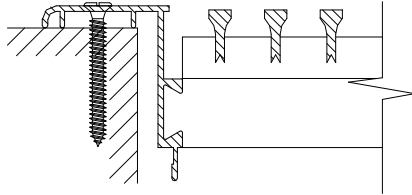

**-B**  
SPRING CLIPS

Clips behind the flange keep grille snug in opening and are not visible from the face.  
Only for floor and sill applications.  
**NOT suitable for wall or ceiling use.**

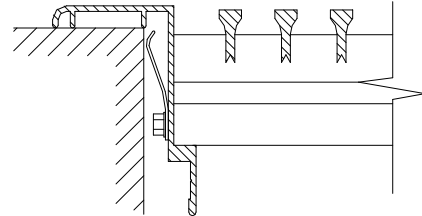

**-C**  
CONCEALED BRACKETS

Grille gets fastened to duct-mounted brackets that are concealed behind the blades.  
Suitable for ceiling, wall, sill or floor installation.

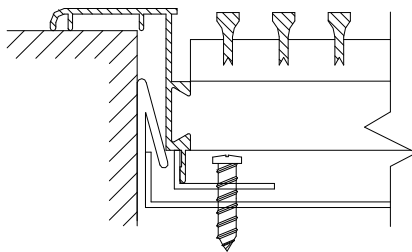

**-D**  
SIDEWALL SCREWHOLES

Screw holes drilled at 45° on inner flange.  
Only available with **-R Removable core.**  
(Removable option not available for floor)  
Suitable for ceiling, wall or sill installation.

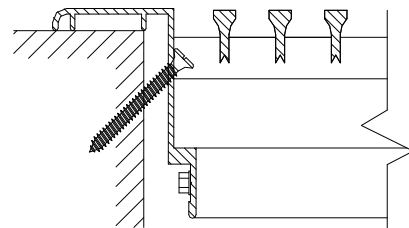

**-TB**  
NO MOUNTING OPTION

Suitable for T-Bar lay-in ceiling & custom applications.  
Account for the flange by ordering 2+ under the T-Bar size.  
i.e.: a 22+x 10+grille will have a 23-11/16+x 11-11/16+OD  
and will fit a standard 2 ft x 1ft T-Bar opening

