

# Bar Linear No Flange Removable Core Grilles

## DABLRN

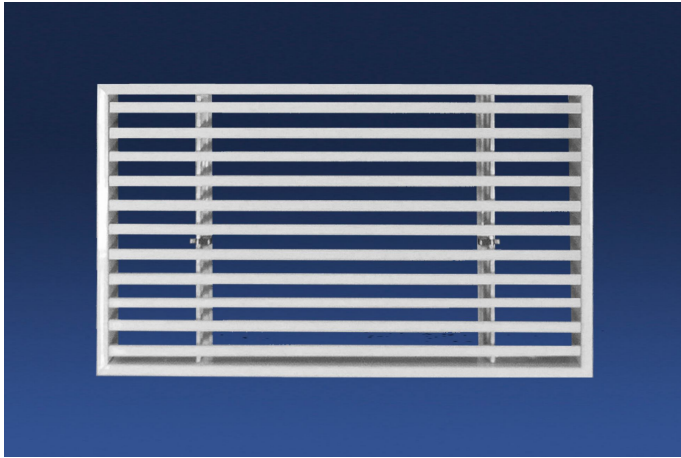

- Fully extruded aluminum construction
- No flange frame designed for a stylish built-in look
- Removable core held in place with clips
- Fixed blades designed for long straight air throw
- Sections longer than 84" are joined together for continuous appearance with the aligning pins provided
- End caps are included (open ends can be specified if required)
- Available on 1/2" increments as standard
- Custom sizes available, but extra charge may apply
- Durable powder coat painted finish
- Plaster finishing is the responsibility of the installer

Not suitable for floor use

**HOW TO ORDER**  
**DABLRN - 00 - TB 30 x 4 COLOR**  
 Blade Mounting Length & White, Silver  
 -00,-01,-15 C, D or TB Height Mill or Brown  
 -30,-82,-84

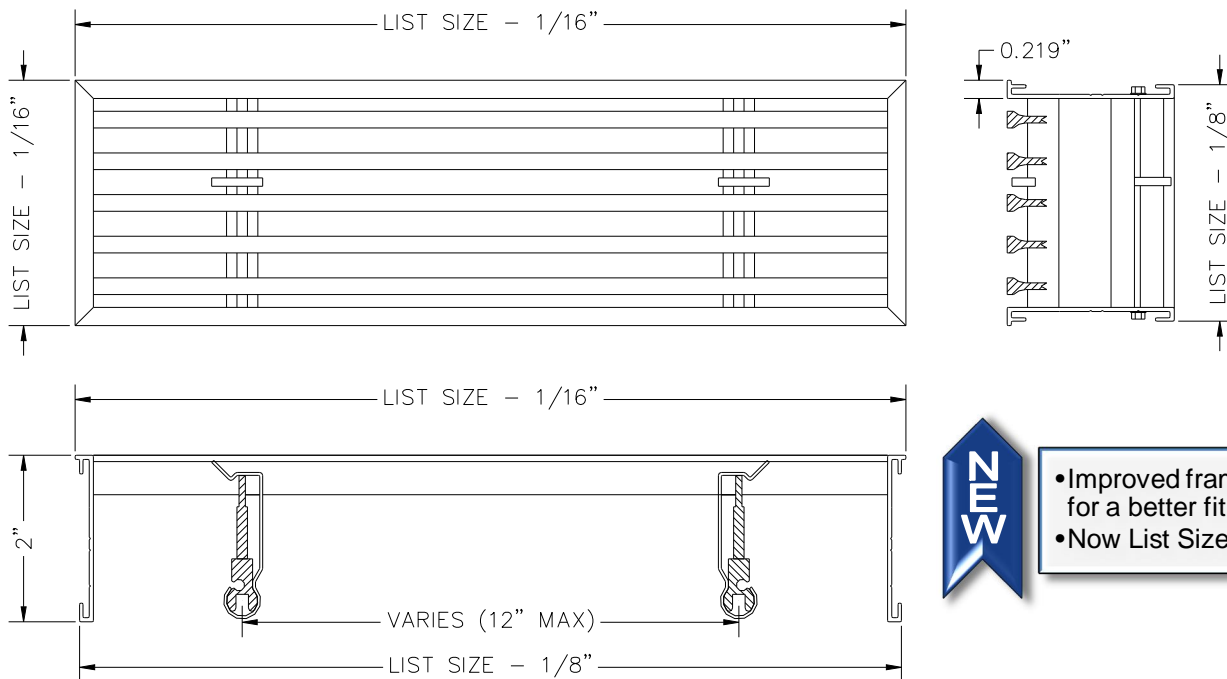

• Improved frame design for a better fit  
 • Now List Size - 1/16"



DESCRIPTION	DABLRN
FACE BLADES	Horizontal Fixed
REAR BLADES	n/a
DAMPER	n/a
MATERIAL	Aluminum
COLOR	White/Silver/Brown/Mill

JOB NAME: \_\_\_\_\_  
 LOCATION: \_\_\_\_\_  
 ARCHITECT: \_\_\_\_\_  
 ENGINEER: \_\_\_\_\_  
 CONTRACTOR: \_\_\_\_\_

**Bar Linear Blade Options**

**-00-**

0° 13/64" blades on 1/2" centers

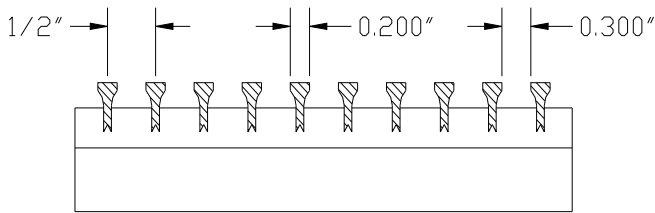

**-01-**

0° 1/4" blades on 1/2" centers

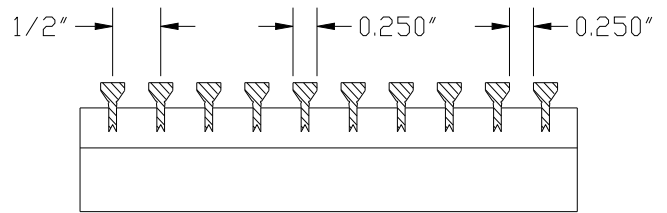

**-15-**

15° 13/64" blades on 1/2" centers

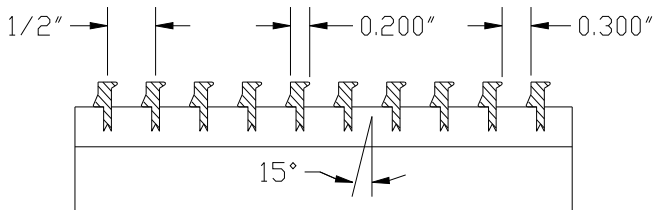

**-30-**

30° 13/64" blades on 1/2" centers

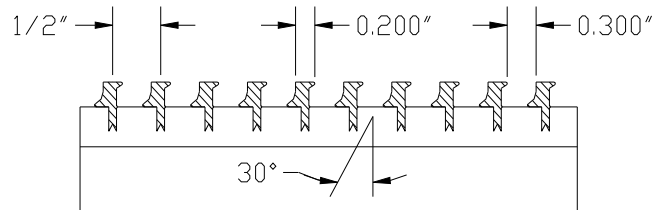

**-82-**

0° 1/8" blades on 1/2" centers

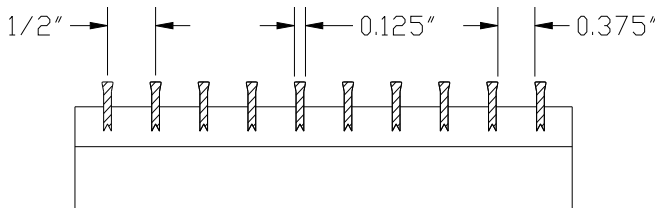

**-84-**

0° 1/8" blades on 1/4" centers

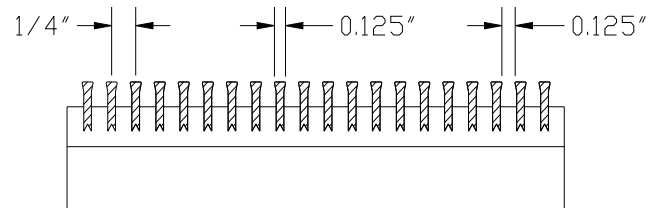

- Additional charges apply for the -84 core option

**Bar Linear Mounting Options**

**-A  
SCREWS**

Color matched screws with countersunk screw holes.  
Suitable for ceiling, wall, sill or floor installation.

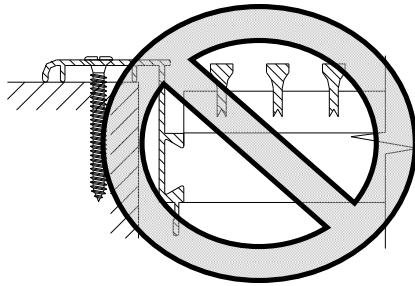

**-B  
SPRING CLIPS**

Clips behind the flange keep grille snug in opening and are not visible from the face.  
Only for floor and sill applications.  
**NOT suitable for wall or ceiling use.**

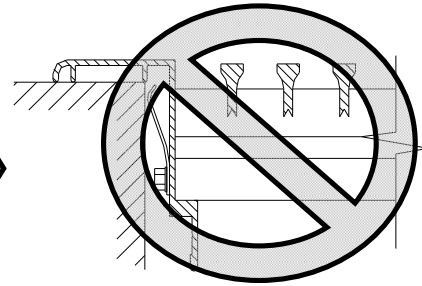

These mounting options are only available with flanged grilles

**-C  
CONCEALED BRACKETS**

Grille gets fastened to duct-mounted brackets that are concealed behind the blades.  
Suitable for ceiling, wall or sill installation.

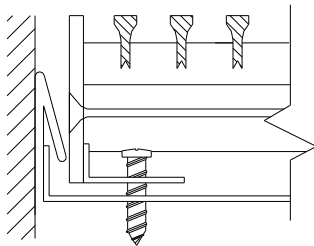

**-D  
SIDEWALL SCREW HOLES**

Screw holes drilled at 45° on inner flange.  
Only available with **-R Removable core.**  
(Removable option not available for floor)  
Suitable for ceiling, wall or sill installation.

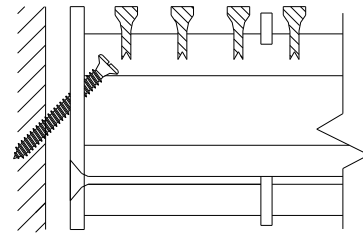

**-TB  
NO MOUNTING OPTION**

Suitable for T-Bar lay-in ceiling & custom applications.  
Please allow some clearance for installation

