

Bar Linear Removable Core Grilles

DABLR



Not suitable for floor use

- Removable core held in place with clips
- Fully extruded aluminum construction for a stylish appearance
- Fixed blades designed for long straight air throw
- Sections joined together for continuous appearance. When longer than 84", aligning pins are provided.
- End caps are included. Open ends can be specified when required.
- Available on 1/2" increments as standard
- Custom sizes available but extra charge may apply
- Durable powdercoat painted finish

HOW TO ORDER

DABLR - 00 - D 30 x 4 COLOR

Grid core	-G	Blade	-00,-01	Width & Height	White
No flange	-N		-15,-30 -82,-84	Mounting A,B,C or D	Silver
					Mill or Brown

Do not leave space if option is not required

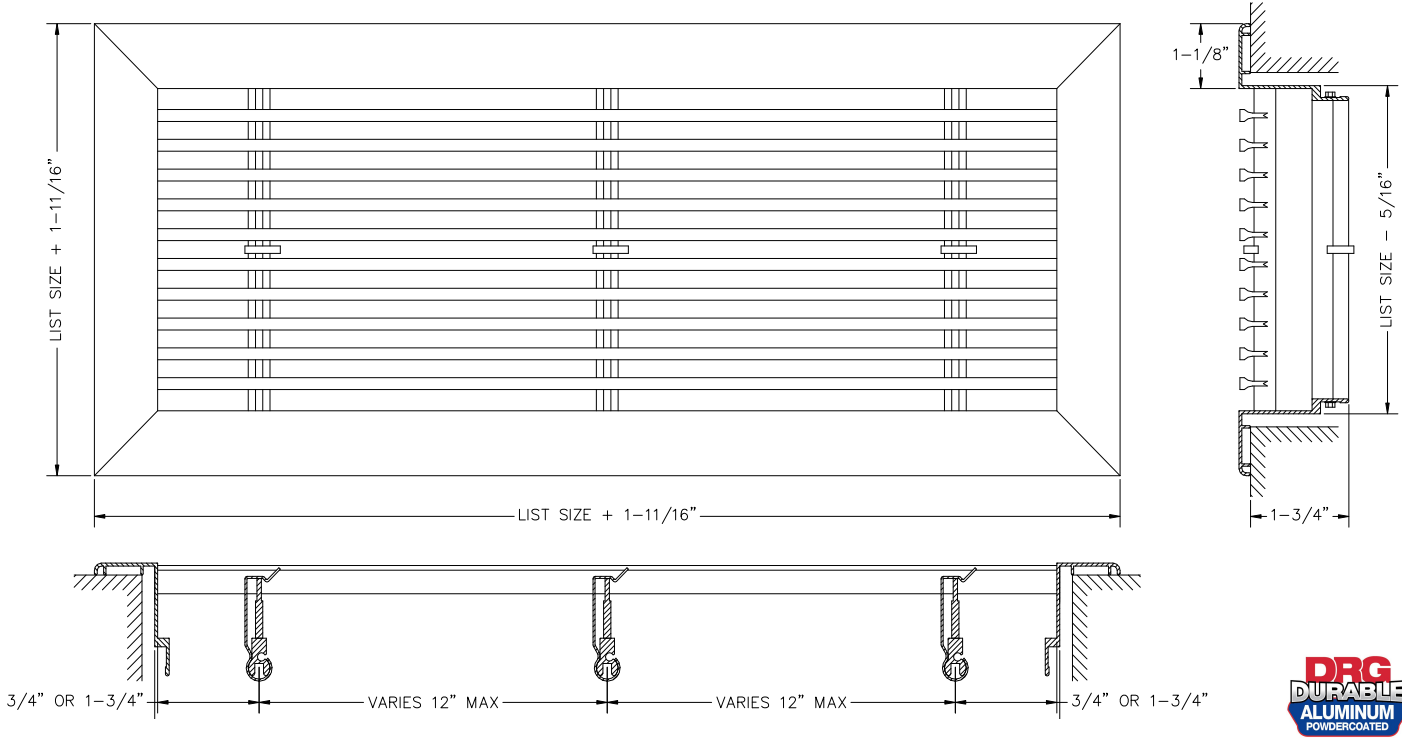

DESCRIPTION	DABLR
FACE BLADES	Horizontal Fixed
REAR BLADES	n/a
DAMPER	n/a
MATERIAL	Aluminum
COLOR	White/Silver/Brown/Mill

JOB NAME: _____

LOCATION: _____

ARCHITECT: _____

ENGINEER: _____

CONTRACTOR: _____

Bar Linear Blade Options

-00-

0° 13/64+blades on 1/2+centers

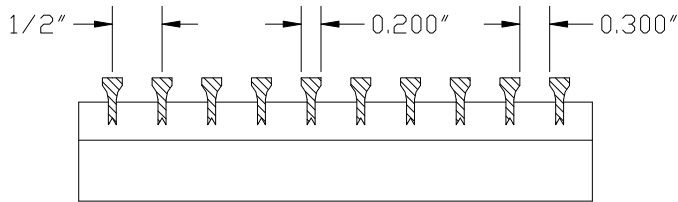

-01-

0° 1/4+blades on 1/2+centers

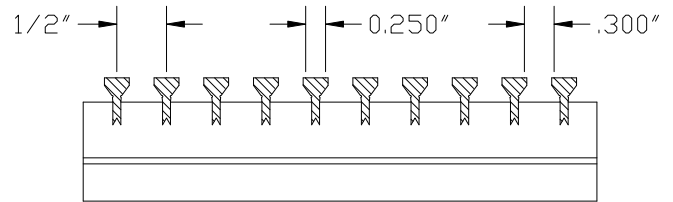

-15-

15° 13/64+blades on 1/2+centers

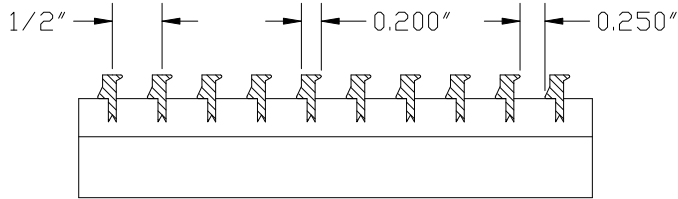

-30-

30° 13/64+blades on 1/2+centers

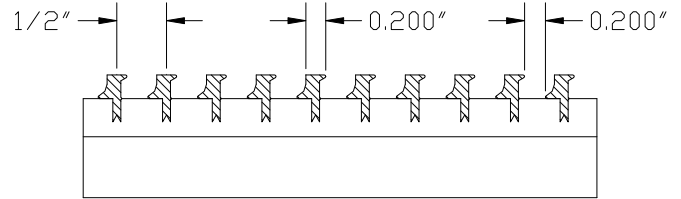

-82-

0° 1/8+blades on 1/2+centers

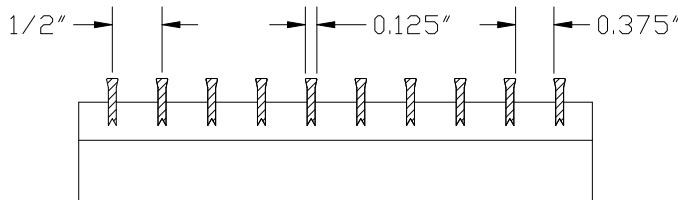

-84-

0° 1/8+blades on 1/4+centers

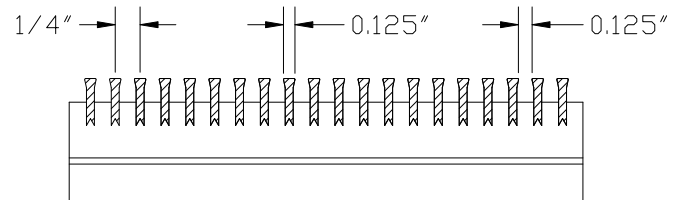

- Additional charges apply for the -84 core option

Bar Linear Mounting Options

-A
SCREWS

Color matched screws with counter-sunk screwholes.
Suitable for ceiling, wall, sill or floor installation.

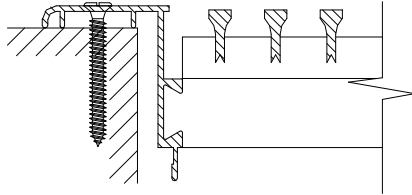

-B
SPRING CLIPS

Clips behind the flange keep grille snug in opening and are not visible from the face.
Only for floor and sill applications.
NOT suitable for wall or ceiling use.

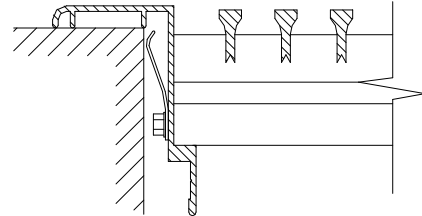

-C
CONCEALED BRACKETS

Grille gets fastened to duct-mounted brackets that are concealed behind the blades.
Suitable for ceiling, wall, sill or floor installation.

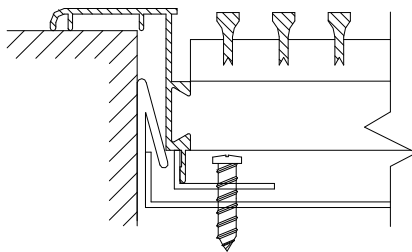

-D
SIDEWALL SCREWHOLES

Screw holes drilled at 45° on inner flange.
Only available with **-R Removable core**.
(Removable option not available for floor)
Suitable for ceiling, wall or sill installation.

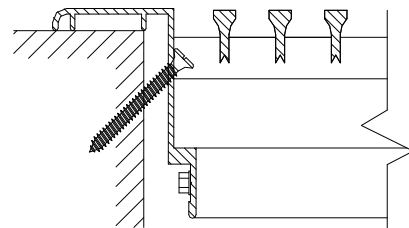

-TB
NO MOUNTING OPTION

Suitable for T-Bar lay-in ceiling & custom applications.
Account for the flange by ordering 2+ under the T-Bar size.
i.e.: a 22+x 10+grille will have a 23-11/16+x 11-11/16+OD
and will fit a standard 2 ft x 1ft T-Bar opening

